

NO10208 RGS 2

Dobbelt stolpegynge

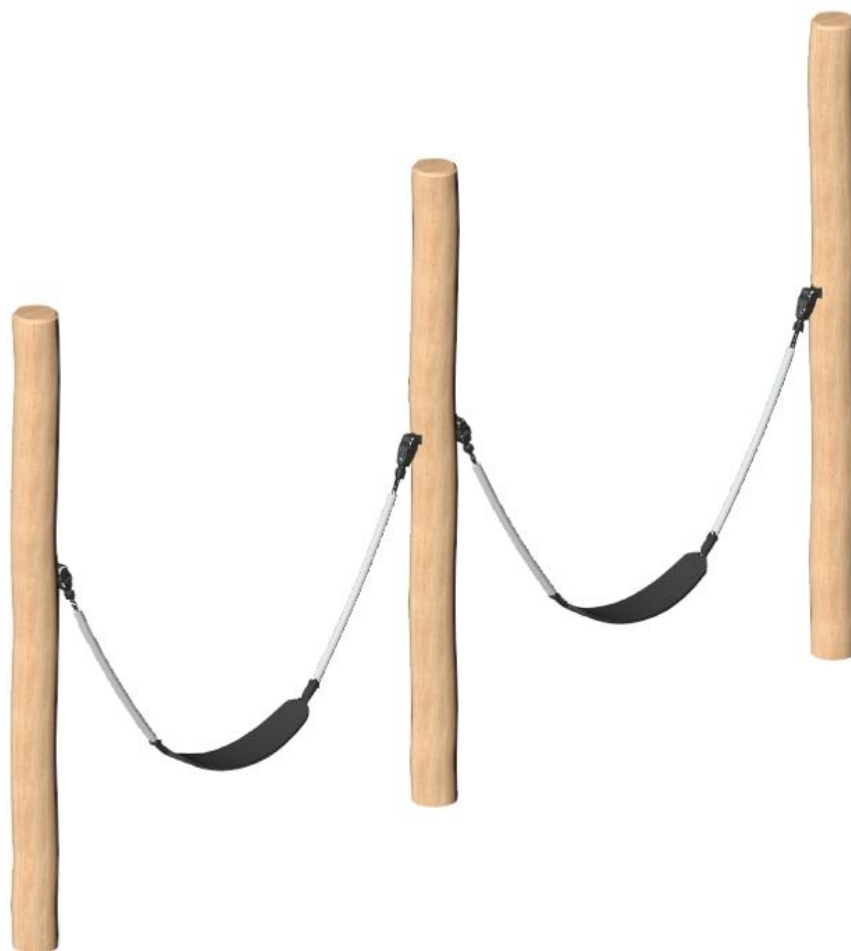

5 -14 år



2 barn



Til afslapning



Balancelæring



< 80 cm
> EN 1176



1 montør



Info

Stolpegynge i robinietræ med remgynge



Reserve dele

For oplysninger omkring reservedele kontakt Noles



Størrelse

L: 300 B: 80 H: 50 cm



Sikkerhed

DS/EN 1176



Materiale

FSC-mærket Robinie kernetræ, kædeled med plastik, poleret rustfri stål og gummi.



Målgruppe

5-14 år



Vægt

110 kg.



Fundament

Produktet funderes ift. krav fra DS/EN 1176
0,1 m³



Faldhøjde

80 cm



Stødområde

315x385 cm

NO10208 RGS 2 Dobbelt stolpegynge



Nr	Navn	Varenr.	Beskrivelse	Dimensioner	Antal	Modtaget
1	Robinie stolper	11423	FSC-mærket Robinie kernetræ	Ø14-16 cm L= 300 cm	3	
2	Gyngelejebeslag	11158	Rustfrit stål		4	
3	Dækprop	11127	Hård plast	Ø42	4	
4	Skiver	10511	Rustfrit stål	M16	4	
5	Møtrik	10512	Rustfrit stål	M16	4	
6	Remgynge	11145	Rustfrit stålkædeled med gummisæde		2	

Stempel / signatur:	Dato: 29.10.2021	Rev: A	Format: A4	Emne: Komponentliste
	Sign: CB	Godkendt: JH	Varenr. NO10208	

1 Overblik

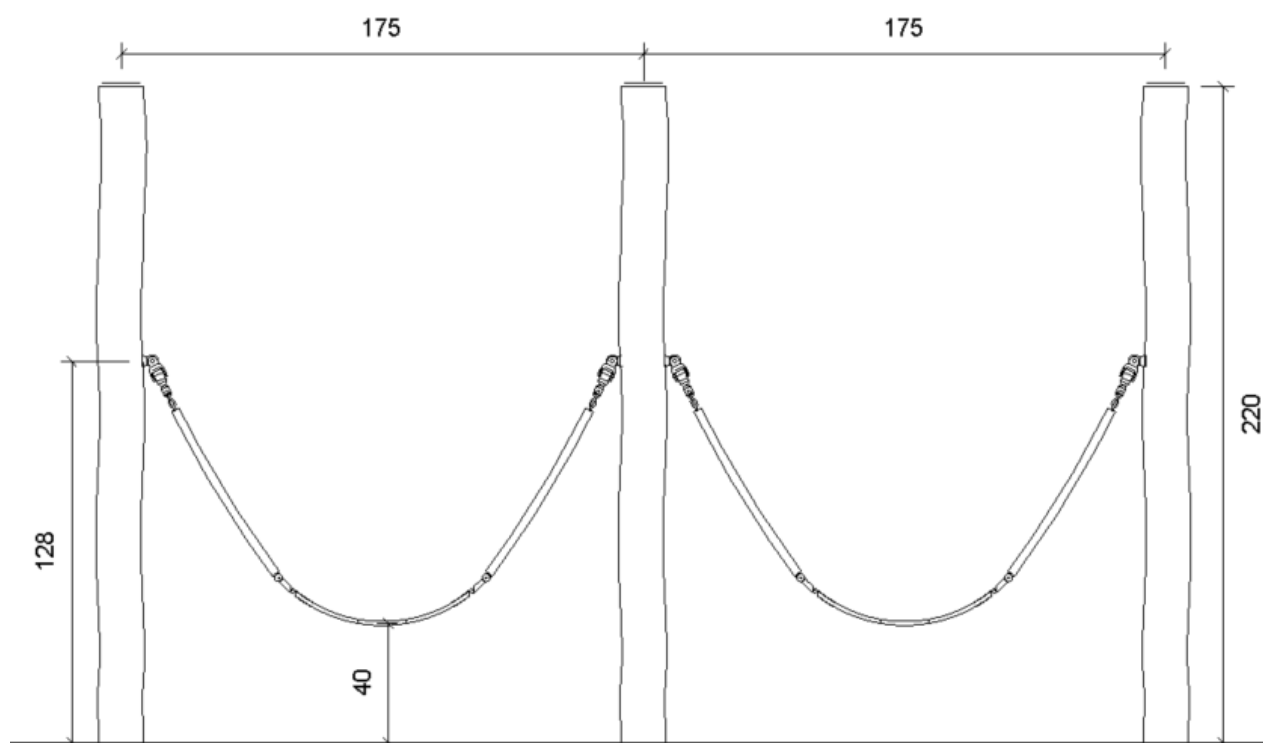

Front
Faldhøjde 80 cm.
Gyngelejebeslag monteres maks. 130 cm. over jorden

Stempel / signatur:

Dato: 29.10.2021

Rev: A

Format: A4

Emne:
Front
Opstalt

Sign: CB

Godkendt: JH

Varenr. NO10208

1 Overblik

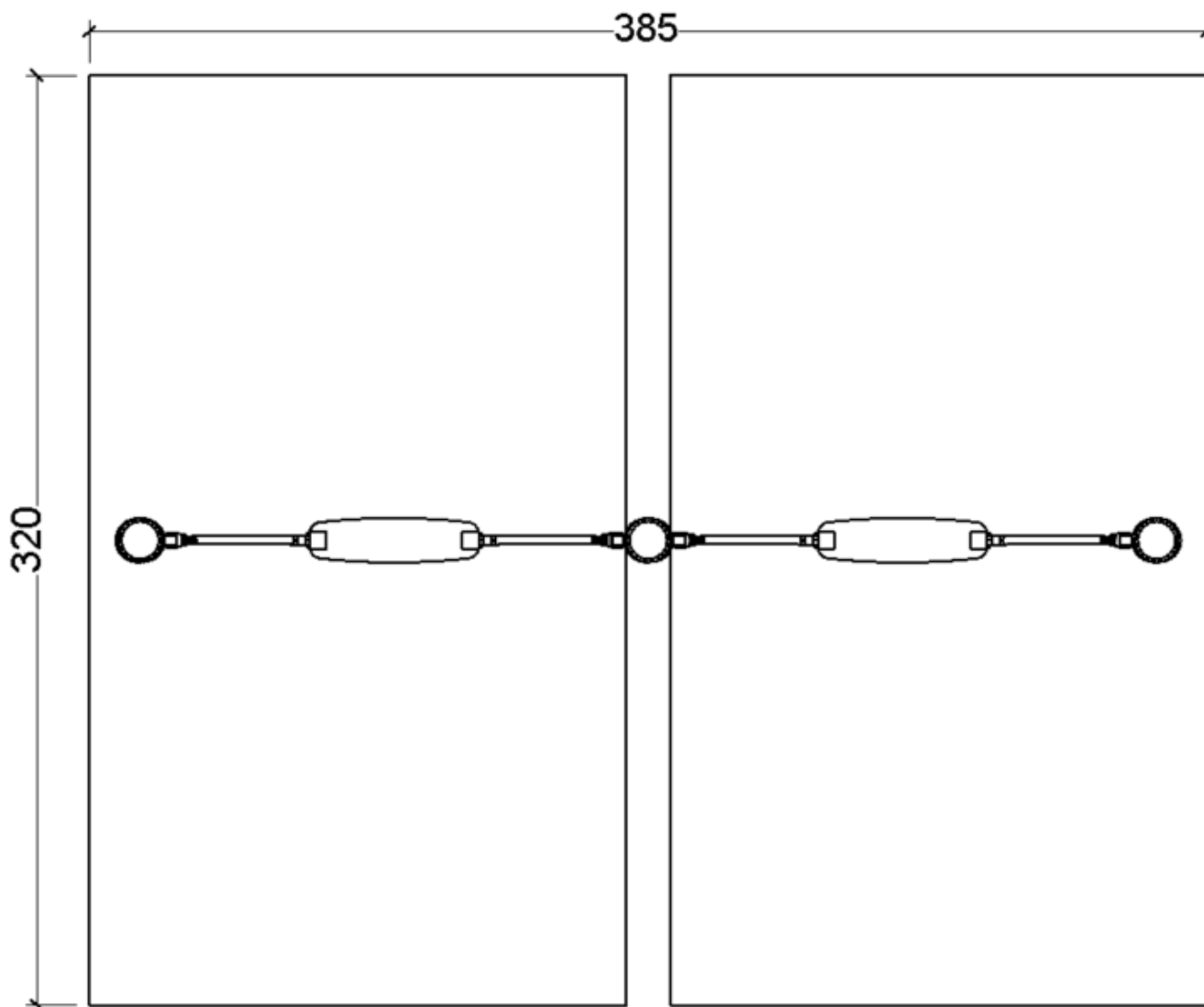

Fra oven
Sikkerhedsareal 315x385 cm

Stempel / signatur:

Dato: 29.10.2021

Rev: A

Format: A4

Emne:
Sikkerhedsareal
Plantegning

Sign: CB

Godkendt: JH

Varenr. NO10208

2 Stolper i jorden

- Marker 3 punkter med efter anvisning på plantegningen til montering af stolper
- Grav 3 huller på 40x40 cm. og sæt stolper på et stødt underlag.
- Fyld derefter op med stolpebeton i 40 cm. højde omkring stolpen
- Fyld jord omkring betonen og i 10 cm. højde over betonen
- Derefter lægges der 30 cm. faldsikkert underlag
- Vent til betonen er hærdet (se leverandørens anvisning)

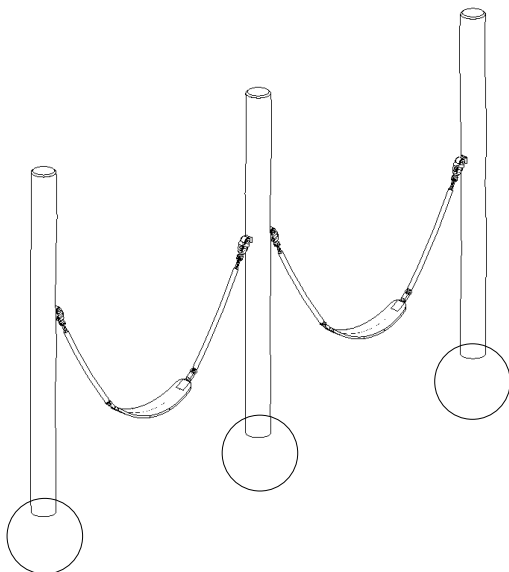

Lokation

Princip

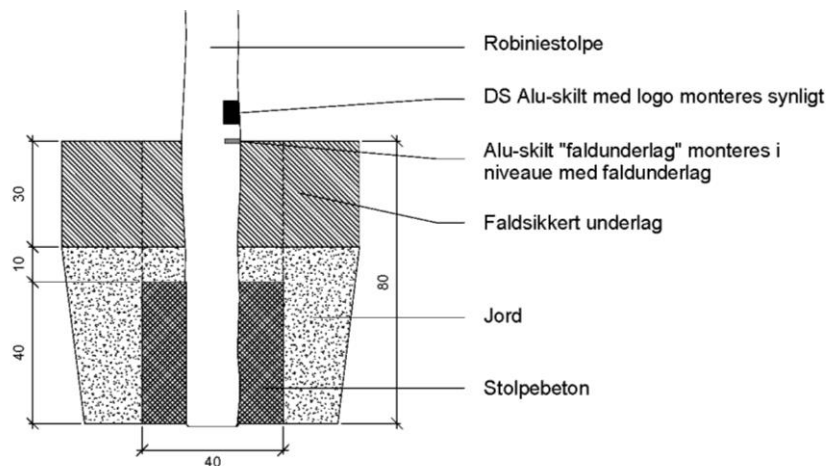

Brug et jordbord på Ø40 cm.

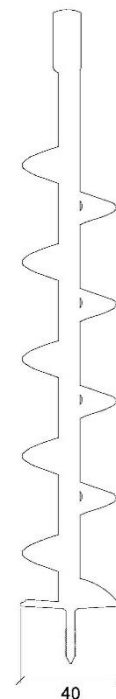

Stempel / signatur:

Dato: 29.10.2021

Rev: A

Format: A4

Emne:
Fundering

Sign: CB

Godkendt: JH

Varenr. NO10208

3 Montering af gyngelejebeslag og gyngerem

- | Nr | Navn |
|----|------------------------|
| 1 | Robinie stolper 300 cm |
| 2 | Gyngelejebeslag |
| 3 | Dækprop Ø42 |
| 4 | Skive M16 |
| 5 | Møtrik M16 |
| 6 | Gyngerem |

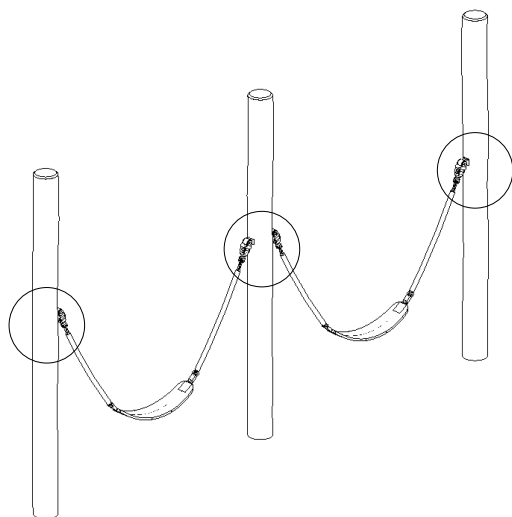

Lokation
Lokation

Princip
Snit

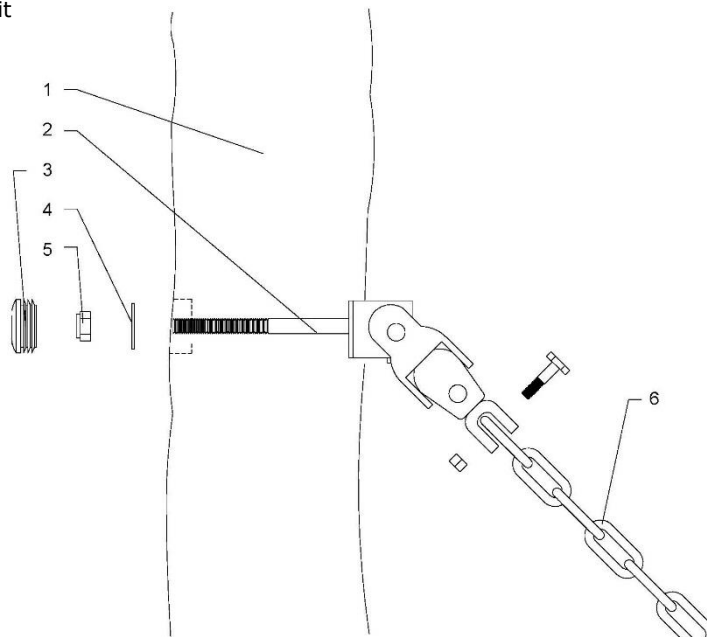

Husk undersænkning ved indgang til gevind

3D model

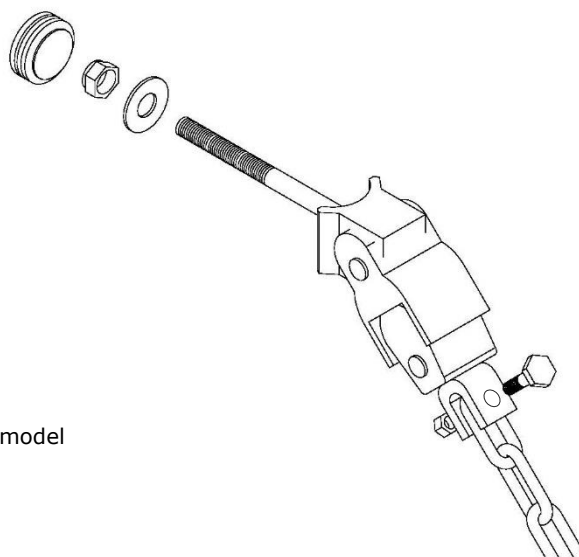

Stempel / signatur:

Dato: 29.10.2021

Rev: A

Format: A4

Emne:
Gyngelejebeslag

Sign: CB

Godkendt: JH

Varenr. NO10208