

— EN Impact Area 21.3 m2
 - - - Falling Space 21.3 m2

Max Falling Height 1000 mm

1:75

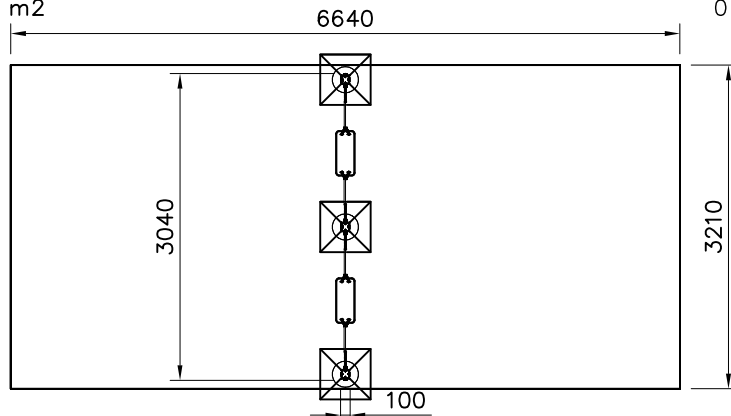

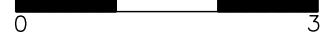

















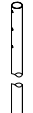



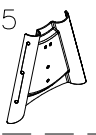

LAPPSET®

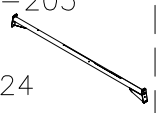
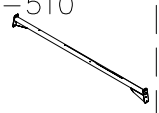
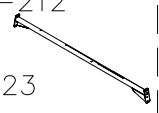
COLOUR OPTIONS

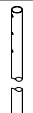
METAL SWINGS

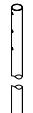
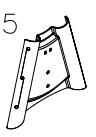
DATE: 11.1.2017

1(2)

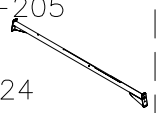
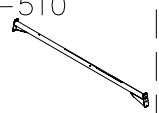
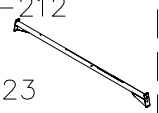
220001M, 220002M								
POST DEEP 260x260x1700	905171-205 RAL 7024		905171-510 HDG		905171-212 RAL 9023			
POST SURFACE 260x260x1700	905171-205 RAL 7024		905171-510 HDG		905171-212 RAL 9023			
220061M								
POST DEEP 121x121x2947	904435-205 RAL 7024		904435-510 HDG		904435-212 RAL 9023			
POST SURFACE 145x150x2412	904432-205 RAL 7024		904432-510 HDG		904432-212 RAL 9023			
PLATE 51x440x499	904422-205 RAL 7024		904422-510 HDG		904422-213 RAL 1018		904422-212 RAL 9023	
BOOM 88x237x2942	904428-205 RAL 7024		904428-510 HDG		904428-212 RAL 9023			
220062M								
POST DEEP 121x121x3367	904436-205 RAL 7024		904436-510 HDG		904436-212 RAL 9023			
POST SURFACE 145x150x2832	904424-205 RAL 7024		904424-510 HDG		904424-212 RAL 9023			
PLATE 51x440x499	904422-205 RAL 7024		904422-510 HDG		904422-213 RAL 1018		904422-212 RAL 9023	
BOOM 88x237x2942	904428-205 RAL 7024		904428-510 HDG		904428-212 RAL 9023			

















LAPPSET®

COLOUR OPTIONS

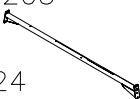
METAL SWINGS

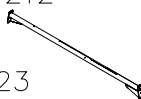
DATE: 11.1.2017

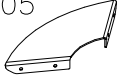
2(2)

220066M								
POST DEEP 121x121x3367	904436-205 RAL 7024		904436-510 HDG		904436-212 RAL 9023			
POST SURFACE 145x150x2832	904424-205 RAL 7024		904424-510 HDG		904424-212 RAL 9023			
PLATE 51x440x499	904422-205 RAL 7024		904422-510 HDG		904422-213 RAL 1018		904422-212 RAL 9023	
BOOM 88x237x2942	905636-205 RAL 7024		905636-510 HDG		905636-212 RAL 9023			
220005								
POST DEEP 350x350x2590	904700-205 RAL 7024							
POST SURFACE 175x175x2386	904484-205 RAL 7024							
PLATE 70x211x582	904548-205 RAL 7024							
BOOM 96x261x3100	904491-205 RAL 7024							

												
<p>$h < 600$</p> <p>Without movement and therefore without Impact Area</p>	<p>Totally hard surfaces.</p> <p>Note. Lappset does <u>not recommend</u> totally hard surfaces at all.</p>	<p>E.g. concrete or asphalt</p> 										
<p>$h < 600$</p> <p>With movement e.g. rocking</p>	<p>Materials with very limited impact attenuating properties.</p>	<p>E.g. wood</p> 										
<p>$h < 1000$</p>	<p>Materials with significant impact attenuating properties.</p>	<p>fine gravel 0–8 mm</p>  <p>grass</p>  <p>unsorted sand</p> 										
<p>$h < 3000$</p>	<p>Loose fill material</p> <p>E.g. sand/gravel 0,25...8 mm D60/D10<3,0 Woodchips 5...30 mm bark 20...80 mm</p>	 <table data-bbox="1021 1691 1332 1792"> <tr> <td>\underline{S}</td> <td>\underline{h}</td> </tr> <tr> <td>30 cm</td> <td>< 2,0 m</td> </tr> <tr> <td>40 cm</td> <td>< 3,0 m</td> </tr> </table>	\underline{S}	\underline{h}	30 cm	< 2,0 m	40 cm	< 3,0 m				
\underline{S}	\underline{h}											
30 cm	< 2,0 m											
40 cm	< 3,0 m											
	<p>Syntethic granulates</p> <table data-bbox="406 1892 758 2060"> <tr> <td>\underline{S}</td> <td>\underline{h}</td> </tr> <tr> <td>40 mm</td> <td>~> 1,2...1,3 m</td> </tr> <tr> <td>50 mm</td> <td>~> 1,5...1,7 m</td> </tr> <tr> <td>60 mm</td> <td>~> 1,8...2,0 m</td> </tr> <tr> <td>70 mm</td> <td>~> 2,1...2,5 m</td> </tr> </table> <p>Note. For accurate values, see manufacturer's instructions.</p>	\underline{S}	\underline{h}	40 mm	~> 1,2...1,3 m	50 mm	~> 1,5...1,7 m	60 mm	~> 1,8...2,0 m	70 mm	~> 2,1...2,5 m	
\underline{S}	\underline{h}											
40 mm	~> 1,2...1,3 m											
50 mm	~> 1,5...1,7 m											
60 mm	~> 1,8...2,0 m											
70 mm	~> 2,1...2,5 m											

REMOVE SAFETY SURFACE/SAND/GRAVEL
TO CHECK FOUNDATION

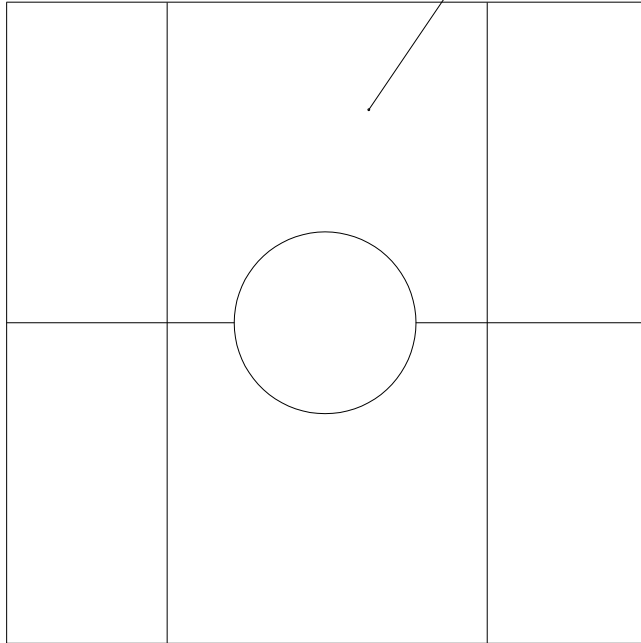

REMOVE SAFETY SURFACE/SAND/GRAVEL
TO CHECK FOUNDATION





Tuotekyltti tulee tuotteen mukana yhdellä seuraavista tavoista:

1) Metallinen tuotekyltti ja kiinnitysruuvit

- Kiinnitä tuotekyltti ruuveilla tolppaan noin 2 metrin korkeuteen kuvan 1 mukaisesti.

2) Tuotekylttitarra

- Puhdista maalattu metalli- tai vaneripinta pölystä ja kosteudesta. Liimaa tarra kuvan 2 mukaisesti.
- Huom. Älä kiinnitä tarraa karheapintaiseen laminaattiin tai maalattuun puuhun.

Vår produktmärkning levereras på ett av följande sätt:

1) Produktskylt i metall

- Fäst skylten med de medföljande skruvarna

2) Självhäftande produktetikett

- Rengör den pulverlackerade metallytan eller laminatyten så att den blir fri från smuts och fukt. Fäst etiketten enligt fig. 2.
- Obs! Fäst ej etiketten på detaljer med skrovlig yta eller på målat trä.

Product label is delivered by one of following ways:

1) Metal product label and screws

- Fasten the label with screws.

2) Label sticker

- Clean the painted metal or plywood surface from dirt and moisture. Fasten the sticker as shown in the figure 2.
- Note. Do not attach the sticker to rough surfaced laminate or painted wood.

La plaque d'informations produit est livrée sous l'une de ces 3 formes :

1) Plaque métallique et vis

- Fixez la plaque à l'aide des vis.

2) Etiquette autocollante

- Avant de coller l'étiquette, nettoyez le composant métallique peint ou la plaque de contreplaqué, de toute saleté. La surface doit être sèche (voir image 2).
- Attention, ne pas coller l'étiquette sur une surface lamellé-collée irrégulière ou sur du bois peint.

Die Auslieferung des Produktaufklebers erfolgt auf eine dieser Arten:



1) Produkt-Schild aus Metall incl. Schrauben

- Die Befestigung des Schildes erfolgt mittels der Schrauben.

2) Aufkleber

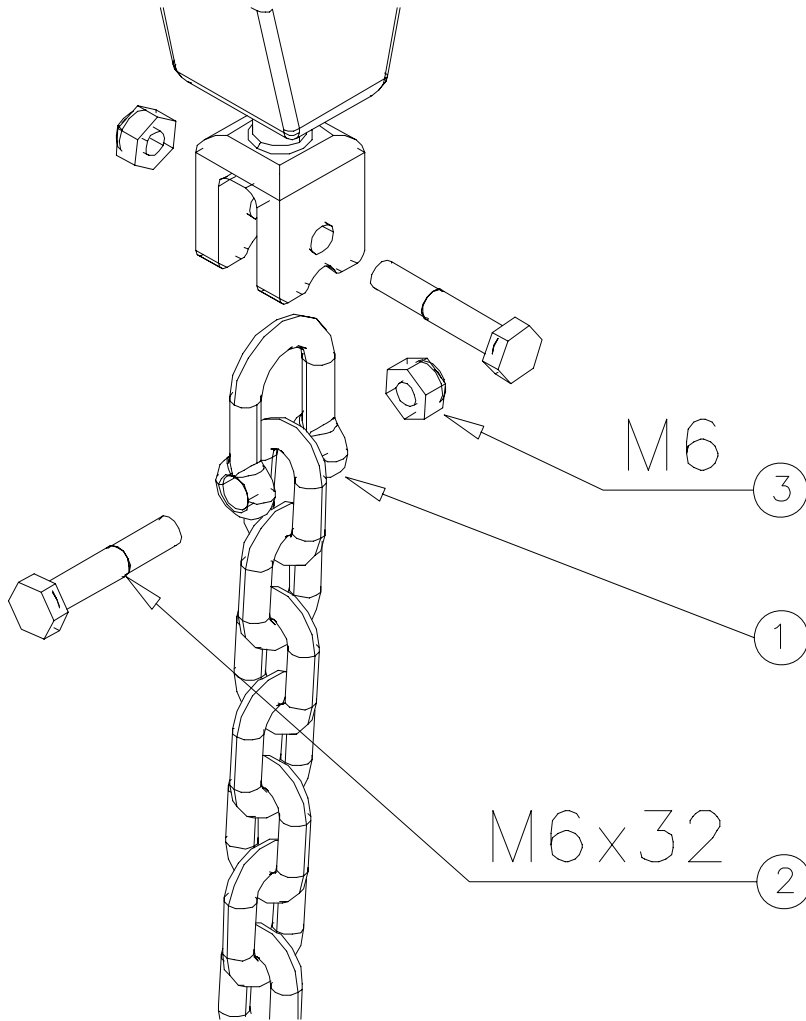
- Entfernen Sie zunächst Schmutz und Feuchtigkeit vom lackierten Metall bzw. von der Holzoberfläche und bringen Sie den Aufkleber wie im Bild oben rechts beschrieben auf den gesäuberten Untergrund auf.
- Beachten Sie: Bringen Sie den Aufkleber nicht auf raues laminiertes oder lackiertes Holz an.

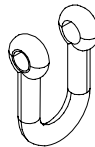
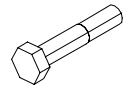

①	PCS	②	PCS
	1		1
M6x38x24		M6x32	
③	PCS		PCS
	1		
M6			
	PCS		PCS
	PCS		PCS
	PCS		PCS
	PCS		PCS
	PCS		PCS

Note:

Use shackle only when chain cannot be attached directly to M8 bolt.

Shackle is never used together with original Lappset chain (2010 model or newer).

Käyttö:

Käytä sakkelia vain silloin kun ketjua ei voida kiinnittää suoraan M8 pultilla.

Sakkelia ei koskaan käytetä alkuperäisten Lappset ketjujen kanssa. (2010 mallit ja uudemmat).